

Steel backing pre-drilled for optional housing anti-rotation pin

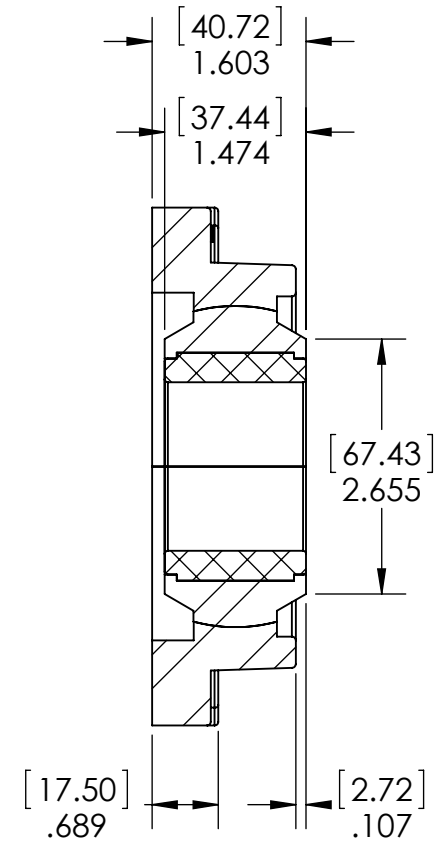
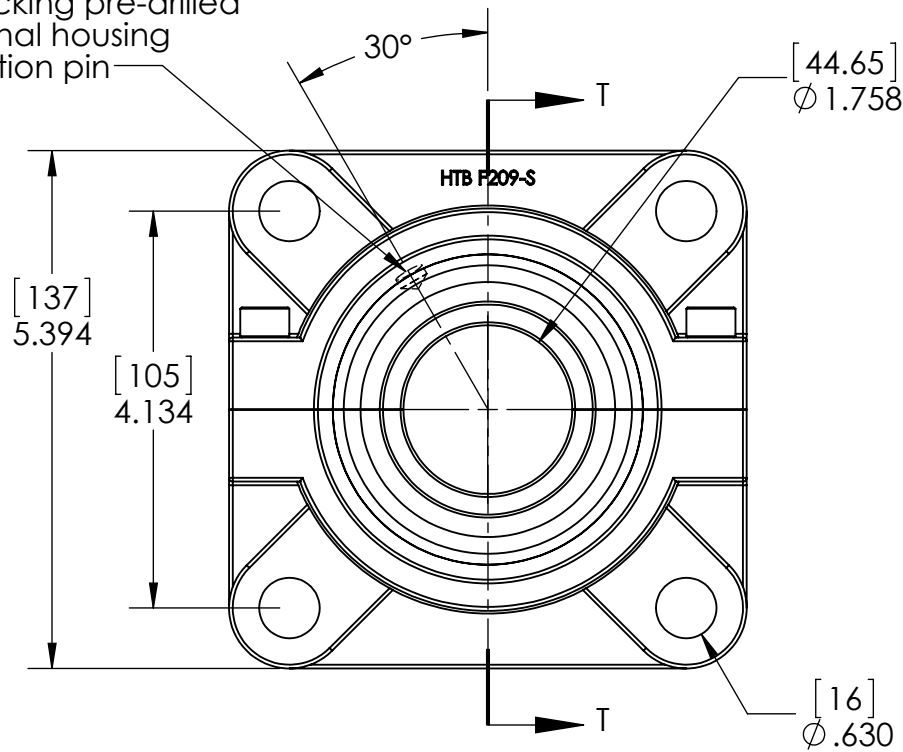

SECTION T-T  
SCALE 1 : 2

Notes:

1: When ordering specify sleeve type by adding the suffix HT750, HT100 or NT600 (eg: 4BF209SHT750-175P) .

HT750: Carbon Grade rated to 750 F  
 HT100: Carbon Grade rated to 1000F  
 NT600: Polymer Composite Grade rated to 600F

2: 2-3 degrees of self alignment

## High Temp Bearings

TITLE:

HT Split 4 Bolt Flange  
Steel Backed Bearing

SIZE	DWG. NO.	REV
<b>A</b>	4BF209SHTxxx-175P	<b>A</b>
SCALE: 1:2		SHEET 1 OF 1